



# Report

US \$44.99

## 2011 Chevrolet Aveo LT

116,000 mi | VIN: KL1TD5DE4BB117857 | Sedan 4 DR | 1.6L I4 F DOHC 16V | Gasoline | Front wheel drive

CARFAX HAS THE MOST ACCIDENT & DAMAGE INFORMATION



### ACCIDENT

Minor to Moderate Damage

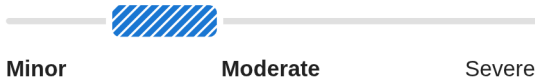

20 Service history records

5 Previous owners

Types of owners: Rental, Personal

Last owned in Washington

49 Detailed records available

This CARFAX Vehicle History Report is based only on information supplied to CARFAX and available as of 4/3/26 at 3:23:19 AM (CDT). Other information about this vehicle, including problems, may not have been reported to CARFAX. Use this report as one important tool, along with a vehicle inspection and test drive, to make a better decision about your next used car.



## Accident / Damage History

Not all accidents / issues are reported to CARFAX

### Event 1

02/03/2015  
**Accident reported: minor to moderate damage**  
-Airbags did not deploy

#### Damage Severity Scale

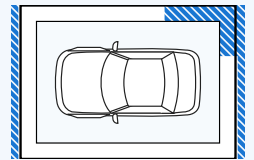
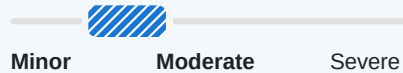







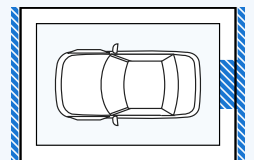
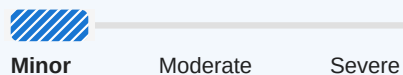

### Event 2

08/30/2019  
**Damage reported: minor damage**

#### Damage Severity Scale





 <b>Additional History</b> Not all accidents / issues are reported to CARFAX	 <b>Owners 1-3</b>	 <b>Owner 4</b>	 <b>Owner 5</b>
<b>Total Loss</b> No total loss reported to CARFAX.	<input checked="" type="checkbox"/> No Issues Reported	<input checked="" type="checkbox"/> No Issues Reported	<input checked="" type="checkbox"/> No Issues Reported
<b>Structural Damage</b> CARFAX recommends that you have this vehicle inspected by a collision repair specialist.	<input checked="" type="checkbox"/> No Issues Reported	<input checked="" type="checkbox"/> No Issues Reported	<input checked="" type="checkbox"/> No Issues Reported
<b>Airbag Deployment</b> No airbag deployment reported to CARFAX.	<input checked="" type="checkbox"/> No Issues Reported	<input checked="" type="checkbox"/> No Issues Reported	<input checked="" type="checkbox"/> No Issues Reported
<b>Odometer Check</b> No indication of an odometer rollback.	<input checked="" type="checkbox"/> No Issues Indicated	<input checked="" type="checkbox"/> No Issues Indicated	<input checked="" type="checkbox"/> No Issues Indicated
<b>Accident / Damage</b> Accident reported: 02/03/2015. Damage reported: 08/30/2019.	Accident Reported	Damage Reported	No New Issues Reported
<b>Manufacturer Recall</b> No open recalls reported to CARFAX. Check for open recalls on GM vehicles at recalls.gm.com.	<input checked="" type="checkbox"/> No Recalls Reported	<input checked="" type="checkbox"/> No Recalls Reported	<input checked="" type="checkbox"/> No Recalls Reported
<b>Basic Warranty</b> Original warranty estimated to have expired.	<b>Warranty Expired</b>	<b>Warranty Expired</b>	<b>Warranty Expired</b>

 <b>Title History</b> CARFAX guarantees the information in this section	 <b>Owners 1-3</b>	 <b>Owner 4</b>	 <b>Owner 5</b>
<b>Damage Brands</b> Salvage   Junk   Rebuilt   Fire   Flood   Hail   Lemon	<input checked="" type="checkbox"/> <b>Guaranteed</b> No Problem	<input checked="" type="checkbox"/> <b>Guaranteed</b> No Problem	<input checked="" type="checkbox"/> <b>Guaranteed</b> No Problem
<b>Odometer Brands</b> Not Actual Mileage   Exceeds Mechanical Limits	<input checked="" type="checkbox"/> <b>Guaranteed</b> No Problem	<input checked="" type="checkbox"/> <b>Guaranteed</b> No Problem	<input checked="" type="checkbox"/> <b>Guaranteed</b> No Problem

 **GUARANTEED** - None of these title problems were reported by a U.S. state Department of Motor Vehicles (DMV). If you find that any of these title problems were reported by a DMV and not included in this report, you may qualify. [View Terms](#) | [View Certificate](#)

 <b>Ownership History</b> The number of owners is estimated	 <b>Owners 1-3</b>	 <b>Owner 4</b>	 <b>Owner 5</b>
Year purchased	2010	2017	2024
Type of owner	See Details	Personal	Personal
Estimated length of ownership	6 yrs. 2 mo.	6 yrs. 10 mo.	2 yrs. 1 mo.
Owned in the following states/provinces	See Details	Washington	Washington
Estimated miles driven per year	See Details	2,760/yr	---
Last reported odometer reading	93,272	107,755	116,000

 <b>Detailed History</b>			
 <b>Owner 1</b> Purchased: 2010			Rental Vehicle 18,905 mi/yr
Date	Mileage	Source	Comments
07/31/2010		US Customs	<b>Vehicle exported from</b> -Republic of Korea and imported to -Oakland, CA
08/23/2010	5	Nevada Motor Vehicle Dept.	<b>Title issued or updated</b> -Registration issued or renewed

Las Vegas, NV  
Title #NV004187009-3

- First owner reported  
- Loan or lien reported  
- Titled or registered as rental vehicle

07/26/2011 Nevada  
Motor Vehicle Dept.  
Las Vegas, NV

**Registration issued or renewed**

12/19/2011 25,017 Auto Auction

**Listed as a manufacturer vehicle**  
- Vehicle sold



Millions of used vehicles are bought and sold at auction every year.

**Owner 2**  
Purchased: 2011

Personal Vehicle

Date	Mileage	Source	Comments
12/22/2011		Washington Motor Vehicle Dept. Tulsa, OK Title #1135610942	<b>Title issued or updated</b> - New owner reported
03/05/2012	28,168	Capitol Chevrolet Cadillac Salem, OR 503-585-4141 capitolauto.com/ 1,460 Customer Favorites	<b>Vehicle serviced</b> - Tire pressure monitoring system checked
05/07/2012	32,404	Fleet/Lease Company	<b>Vehicle sold</b>
05/12/2012		Dealer Inventory	<b>Vehicle offered for sale</b>
05/14/2012		Findlay Honda Spokane Spokane, WA 509-353-4797 findlaydowntownhondaspokane.com 2,686 Customer Favorites	<b>Vehicle serviced</b> - Maintenance inspection completed - Air filter replaced - Fluids checked - Oil and filter changed - Wiper(s) replaced
05/24/2012	32,407	Findlay Honda Spokane Spokane, WA 509-353-4797 findlaydowntownhondaspokane.com 2,686 Customer Favorites	<b>Vehicle serviced</b> - Vehicle washed/detailed
05/24/2012	32,419	Camp Chevrolet Spokane, WA 509-456-7890 campchevrolet.com 1,815 Customer Favorites	<b>Vehicle serviced</b> - Maintenance inspection completed - A/C compressor replaced - Tire condition and pressure checked
06/03/2012		Idaho Motor Vehicle Dept.	<b>Vehicle purchase reported</b>
06/13/2012		Idaho Motor Vehicle Dept. Rathdrum, ID	<b>Registration issued or renewed</b> - Vehicle color noted as White

**Owner 3**  
Purchased: 2012



**Low mileage!** This owner drove less than the industry average of 15,000 miles per year.

Personal Vehicle  
14,217 mi/yr

Date	Mileage	Source	Comments
07/23/2012		Idaho	<b>Title issued or updated</b>

Motor Vehicle Dept.  
Rathdrum, ID  
Title #121020493

-New owner reported  
-Loan or lien reported  
-Vehicle color noted as White

09/07/2012

Idaho  
Motor Vehicle Dept.  
Rathdrum, ID  
Title #121020493

**Registration issued or renewed**  
-Vehicle color noted as White

10/08/2012

35,000

Findlay Honda Spokane  
Spokane, WA  
509-353-4797  
findlaydowntownhondaspokane.com  
♥ 2,686 Customer Favorites



**Vehicle serviced**

10/13/2012

35,782

AutoNation Chevrolet Spokane Valley  
Spokane Valley, WA  
509-924-1150  
autonationchevroletspokanevalley.com/  
♥ 71 Customer Favorites



**Vehicle serviced**  
-Maintenance inspection completed  
-Fuel pump replaced

08/21/2013

Idaho  
Motor Vehicle Dept.  
Rathdrum, ID  
Title #121020493

**Registration issued or renewed**  
-Vehicle color noted as White

12/02/2013

48,790

George Gee Cadillac Kia  
Coeur D Alene, ID  
208-667-7416  
geekia.net/  
♥ 2,994 Customer Favorites



**Vehicle serviced**  
-Maintenance inspection completed  
-Oil and filter changed  
-Transmission checked

09/10/2014

Idaho  
Motor Vehicle Dept.  
Rathdrum, ID  
Title #121020493

**Registration issued or renewed**  
-Vehicle color noted as White

02/03/2015

Damage Report



**Accident reported: minor to moderate damage**  
-Damage to right rear  
-Airbags did not deploy

**CARFAX HAS THE MOST  
ACCIDENT & DAMAGE  
INFORMATION**

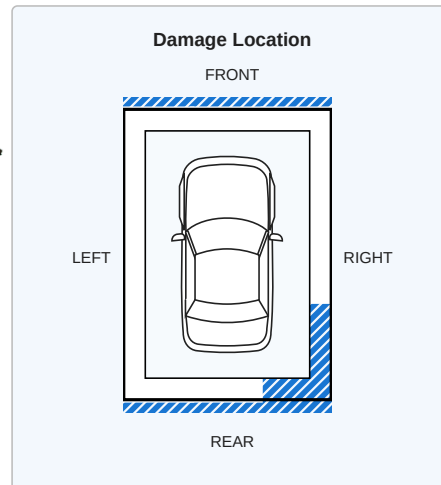
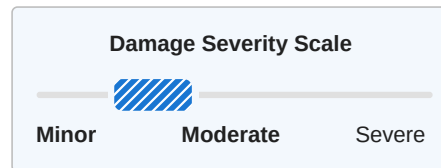



02/27/2015

66,303

Service Facility



**Vehicle serviced**  
-Oil and filter changed





09/05/2015	74,328	Meineke Car Care Center Post Falls, ID 208-777-0639 meineke.com ♥ 7 Customer Favorites		<b>Vehicle serviced</b> -Maintenance inspection completed -Alignment checked -Ignition coil(s) replaced -Spark plug(s) replaced -Thrust angle alignment performed
09/10/2015		Idaho Motor Vehicle Dept. Rathdrum, ID Title #121020493		<b>Registration issued or renewed</b> -Vehicle color noted as White
04/15/2016	85,055	Service Facility		<b>Vehicle serviced</b> -Tire(s) balanced -Tire(s) replaced
09/22/2016		Idaho Motor Vehicle Dept. Rathdrum, ID Title #121020493		<b>Registration issued or renewed</b> -Registration updated when owner moved the vehicle to a new location -Vehicle color noted as White
11/02/2016		Dave Smith Motors Kellogg, ID 208-784-1208 davesmith.com/		<b>Vehicle offered for sale</b>
11/17/2016		Idaho Motor Vehicle Dept. Rathdrum, ID Title #121020493		<b>Title issued or updated</b> -Vehicle color noted as White
02/22/2017	93,272	Dealer Inventory		<b>Vehicle offered for sale</b>

 **Owner 4**  
Purchased: 2017



**Low mileage!** This owner drove less than the industry average of 15,000 miles per year.

Personal Vehicle  
2,760 mi/yr

Date	Mileage	Source		Comments
03/17/2017		Washington Motor Vehicle Dept. Spokane, WA Title #1701414581		<b>Title issued or updated</b> -New owner reported
05/24/2017	94,178	Divine's Auto Center - Downtown Spokane, WA 509-455-8622 divinesauto.com ♥ 432 Customer Favorites		<b>Vehicle serviced</b> -Engine checked
07/20/2017	94,809	Divine's Auto Center - North Spokane, WA 509-483-3753 divinesauto.com ♥ 212 Customer Favorites		<b>Vehicle serviced</b> -Air filter checked -Body lubricated -Brakes checked -Fluids checked -Oil and filter changed
02/22/2018		Washington Motor Vehicle Dept. Spokane, WA Title #1701414581		<b>Registration issued or renewed</b>
04/20/2018	97,601	Divine's Auto Center - North Spokane, WA 509-483-3753 divinesauto.com ♥ 212 Customer Favorites		<b>Vehicle serviced</b> -Air filter checked -Body lubricated -Fluids checked -Oil and filter changed
11/21/2018	99,522	Divine's Auto Center - Downtown Spokane, WA 509-455-8622		<b>Vehicle serviced</b> -Air filter checked -Brakes checked

divinesauto.com  
♥ 432 Customer Favorites

-Maintenance reminder reset  
-Oil and filter changed  
-Tire condition and pressure checked

03/18/2019 100,430

Divine's Auto Center - Downtown  
Spokane, WA  
509-455-8622  
divinesauto.com  
♥ 432 Customer Favorites



**Vehicle serviced**  
-Antifreeze/coolant flushed/changed  
-Heater hose(s) replaced  
-Lower radiator hose replaced  
-Radiator hose(s) replaced  
-Upper radiator hose replaced

03/25/2019

Washington  
Motor Vehicle Dept.  
Spokane, WA  
Title #1701414581

**Registration issued or renewed**

08/30/2019

Damage Report

**Damage reported: minor damage**  
-Damage to rear

**CARFAX HAS THE MOST  
ACCIDENT & DAMAGE  
INFORMATION**

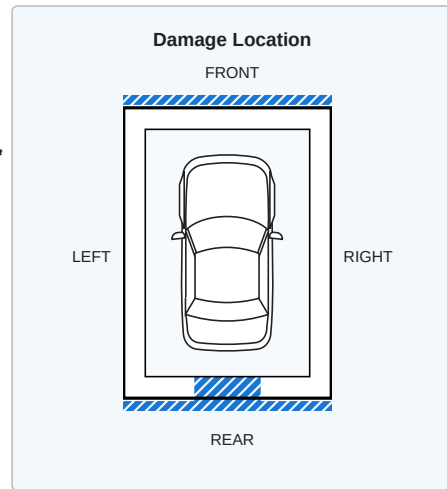
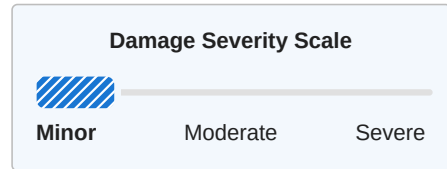

11/11/2019 103,095

Spokane Quick Lube  
Spokane, WA  
509-327-2262  
spokanequicklube.com  
♥ 38 Customer Favorites



**Vehicle serviced**  
-Recommended maintenance performed

03/28/2020

Washington  
Motor Vehicle Dept.  
Spokane, WA  
Title #1701414581

**Registration issued or renewed**  
-Registration updated when owner moved the vehicle to a new location

02/25/2021

Washington  
Motor Vehicle Dept.  
Spokane, WA  
Title #1701414581

**Registration issued or renewed**

07/23/2021 106,634

Tire-Rama - Spokane  
Spokane, WA  
509-489-7777  
tirerama.com



**Vehicle serviced**  
-Tire condition and pressure checked  
-Tire(s) mounted  
-Tire(s) replaced

03/11/2022

Washington  
Motor Vehicle Dept.  
Spokane, WA  
Title #1701414581

**Registration issued or renewed**

04/23/2022 107,755

Spokane Quick Lube  
Spokane, WA  
509-327-2262



**Vehicle serviced**  
-Recommended maintenance performed

spokanequicklube.com  
❤️ 38 Customer Favorites



02/27/2023

Washington  
Motor Vehicle Dept.  
Spokane, WA  
Title #1701414581

**Registration issued or renewed**

 **Owner 5**  
Purchased: 2024

Personal Vehicle

Date	Mileage	Source		Comments
02/05/2024		Washington Motor Vehicle Dept. Spokane, WA Title #1879796614		<b>Title issued or updated</b> -New owner reported
03/22/2024	111,940	Golden Rule Brake - Northside Spokane, WA 509-489-4890 goldenrulebrake.com/		<b>Vehicle serviced</b> -Ball joint(s) replaced -Control arm(s) replaced
11/04/2024	116,000	Valvoline Instant Oil Change Spokane, WA 509-467-0266 vioc.com ❤️ 177 Customer Favorites		<b>Vehicle serviced</b> -Automatic transmission serviced -Oil and filter changed -Transmission fluid changed
02/03/2025		Washington Motor Vehicle Dept. Spokane, WA Title #1879796614		<b>Registration issued or renewed</b>

Have Questions? Consumers, please visit our Help Center at [www.carfax.com](http://www.carfax.com). Dealers or Subscribers, please visit our Help Center at [www.carfaxonline.com](http://www.carfaxonline.com).

## Glossary

### Accident Indicator

CARFAX receives information about accidents in all 50 states, the District of Columbia and Canada.

Not every accident is reported to CARFAX. As details about the accident become available, those additional details are added to the CARFAX Vehicle History Report. CARFAX recommends that you have this vehicle inspected by a qualified mechanic.

- According to the National Safety Council, Injury Facts, 2021 edition, 5% of the 276 million registered vehicles in the U.S. were involved in an accident in 2019. Over 77% of these were considered minor or moderate.
- This CARFAX Vehicle History Report is based only on information supplied to CARFAX and available as of 4/3/26 at 3:23:19 AM (CDT). Other information about this vehicle, including problems, may not have been reported to CARFAX. Use this report as one important tool, along with a vehicle inspection and test drive, to make a better decision about your next used car.

### Damage Indicator

Damage can be a result of many different types of events. Examples include contact with objects (other cars, trees, traffic signs, road debris, etc), vandalism, or weather-related events. Not every damage event is reported to CARFAX. As details about the damage event become available, those additional details are added to the CARFAX Vehicle History Report. CARFAX recommends that you have this vehicle inspected by a qualified mechanic.

- This CARFAX Vehicle History Report is based only on information supplied to CARFAX and available as of 4/3/26 at 3:23:19 AM (CDT). Other information about this vehicle, including problems, may not have been reported to CARFAX. Use this report as one important tool, along with a vehicle inspection and test drive, to make a better decision about your next used car.

### Damage Severity

Damage events result in one of the following severity levels:

- Minor: Generally, minor damage is cosmetic (including dents or scratches), may only require reconditioning, and typically does not compromise a vehicle's operation and/or safety.
- Moderate: Moderate damage may affect multiple components of the vehicle and may impair the vehicle's operation and/or safety.
- Severe: Severe damage usually affects multiple components of the vehicle and is likely to compromise the vehicle's operation and/or safety.

CARFAX recommends getting a pre-purchase inspection at a certified collision repair facility.

### First Owner

When the first owner(s) obtains a title from a Department of Motor Vehicles as proof of ownership.

### New Owner Reported

When a vehicle is sold to a new owner, the Title must be transferred to the new owner(s) at a Department of Motor Vehicles.

