



# Report

US \$44.99

## 2012 Hyundai Elantra Limited

127,231 mi | VIN: KMHDH4AE3CU268786 |

Sedan 4 DR | 1.8L I4 F DOHC 16V | Gasoline | Front wheel drive

CARFAX HAS THE MOST ACCIDENT & DAMAGE INFORMATION

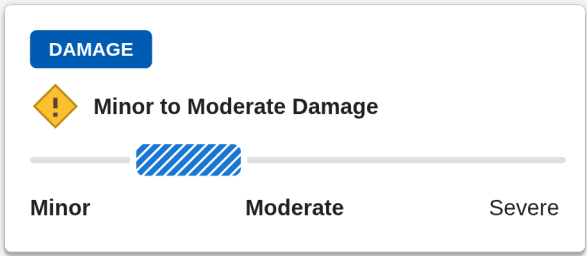

24 Service history records

At least 1 open recall

5 Previous owners

Personal vehicle

Last owned in Washington

This CARFAX Vehicle History Report is based only on information supplied to CARFAX and available as of 4/3/26 at 3:22:58 AM (CDT). Other information about this vehicle, including problems, may not have been reported to CARFAX. Use this report as one important tool, along with a vehicle inspection and test drive, to make a better decision about your next used car.

## Accident / Damage History

Not all accidents / issues are reported to CARFAX

### Event 1

11/26/2019

#### Accident reported: minor damage

- Vehicle involved in a sideswipe collision with another motor vehicle
- Functional damage reported
- Airbags did not deploy

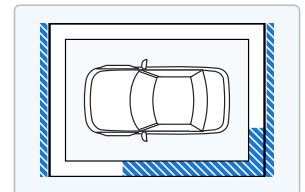
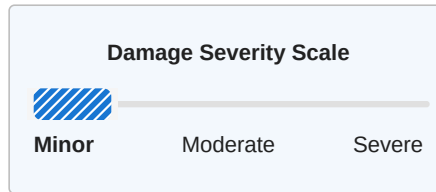

### Event 2

03/26/2021

#### Damage reported: minor to moderate damage

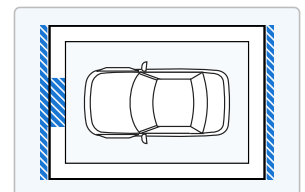
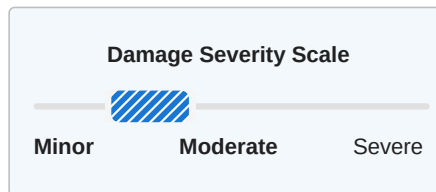









### Event 3

01/17/2026

### Accident reported



- Vehicle involved in a rear-end collision with another motor vehicle
- Airbags did not deploy

 <b>Additional History</b> Not all accidents / issues are reported to CARFAX	 <b>Owners 1-3</b>	 <b>Owner 4</b>	 <b>Owner 5</b>
<b>Total Loss</b> No total loss reported to CARFAX.	<input checked="" type="checkbox"/> No Issues Reported	<input checked="" type="checkbox"/> No Issues Reported	<input checked="" type="checkbox"/> No Issues Reported
<b>Structural Damage</b> CARFAX recommends that you have this vehicle inspected by a collision repair specialist.	<input checked="" type="checkbox"/> No Issues Reported	<input checked="" type="checkbox"/> No Issues Reported	<input checked="" type="checkbox"/> No Issues Reported
<b>Airbag Deployment</b> No airbag deployment reported to CARFAX.	<input checked="" type="checkbox"/> No Issues Reported	<input checked="" type="checkbox"/> No Issues Reported	<input checked="" type="checkbox"/> No Issues Reported
<b>Odometer Check</b> No indication of an odometer rollback.	<input checked="" type="checkbox"/> No Issues Indicated	<input checked="" type="checkbox"/> No Issues Indicated	<input checked="" type="checkbox"/> No Issues Indicated
<b>Accident / Damage</b> Accidents reported: 11/26/2019 and 01/17/2026. Damage reported: 03/26/2021.	<input checked="" type="checkbox"/> No Issues Reported	Accident Reported	Accident Reported
<b>Manufacturer Recall</b> At least 1 manufacturer recall requires repair. Most recalls can be repaired free of charge.	<input checked="" type="checkbox"/> No Recalls Reported	Recall Reported	No New Recalls Reported
<b>Basic Warranty</b> Original warranty estimated to have expired.	Warranty Expired	Warranty Expired	Warranty Expired

 <b>Title History</b> CARFAX guarantees the information in this section	 <b>Owners 1-3</b>	 <b>Owner 4</b>	 <b>Owner 5</b>
<b>Damage Brands</b> Salvage   Junk   Rebuilt   Fire   Flood   Hail   Lemon	<input checked="" type="checkbox"/> <b>Guaranteed</b> No Problem	<input checked="" type="checkbox"/> <b>Guaranteed</b> No Problem	<input checked="" type="checkbox"/> <b>Guaranteed</b> No Problem
<b>Odometer Brands</b> Not Actual Mileage   Exceeds Mechanical Limits	<input checked="" type="checkbox"/> <b>Guaranteed</b> No Problem	<input checked="" type="checkbox"/> <b>Guaranteed</b> No Problem	<input checked="" type="checkbox"/> <b>Guaranteed</b> No Problem

 **GUARANTEED** - None of these title problems were reported by a U.S. state Department of Motor Vehicles (DMV). If you find that any of these title problems were reported by a DMV and not included in this report, you may qualify.  
[View Terms](#) | [View Certificate](#)

 <b>Ownership History</b> The number of owners is estimated	 <b>Owners 1-3</b>	 <b>Owner 4</b>	 <b>Owner 5</b>
Year purchased	2011	2016	2024
Type of owner	Personal	Personal	Personal
Estimated length of ownership	4 yrs. 8 mo.	7 yrs. 3 mo.	2 yrs. 1 mo.
Owned in the following states/provinces	See Details	Florida, Washington	Washington
Estimated miles driven per year	See Details	4,913/yr	---
Last reported odometer reading	65,648	101,715	127,231

 <b>Detailed History</b>	
 <b>Owner 1</b> Purchased: 2011	Personal Vehicle 15,079 mi/yr

Date	Mileage	Source	Comments
08/12/2011		Hyundai Motor America	<b>Vehicle manufactured and shipped to Florida</b> -Original Manufacturer's Suggested -Retail Price: \$23,605 -Black Noir Pearl exterior -Beige interior
09/20/2011	2	Doral Hyundai Doral, FL 305-591-5400 doralhyundai.com	<b>Vehicle offered for sale</b>
09/21/2011	4	Doral Hyundai Doral, FL 305-591-5400 doralhyundai.com/  <b>1,038</b> Customer Favorites	 <b>Vehicle serviced</b> -Pre-delivery inspection completed -Accessories installed -Nitrogen fill tires
09/26/2011		Florida Motor Vehicle Dept. Miami, FL	<b>Registration issued or renewed</b> -Titled or registered as personal vehicle -Vehicle color noted as Black
10/12/2011		Doral Hyundai Doral, FL 305-591-5400 doralhyundai.com/  <b>1,038</b> Customer Favorites	 <b>Vehicle serviced</b>
10/12/2011	17	Florida Motor Vehicle Dept.	<b>Vehicle purchase reported</b>
11/10/2011		Florida Motor Vehicle Dept. Miami, FL Title #0107545842	<b>Title issued or updated</b> -Registration issued or renewed -First owner reported -Titled or registered as personal vehicle -Loan or lien reported -Vehicle color noted as Black
11/23/2011	3,646	Doral Hyundai Doral, FL 305-591-5400 doralhyundai.com/  <b>1,038</b> Customer Favorites	 <b>Vehicle serviced</b> -Maintenance inspection completed -Oil and filter changed
03/02/2012	7,636	Doral Hyundai Doral, FL 305-591-5400 doralhyundai.com/  <b>1,038</b> Customer Favorites	 <b>Vehicle serviced</b> -Maintenance inspection completed -Fluids checked -Oil and filter changed -Tire condition and pressure checked -Tires rotated
05/07/2012		Florida Motor Vehicle Dept. Miami, FL Title #0107545842	<b>Registration issued or renewed</b> -Titled or registered as personal vehicle -Loan or lien reported -Vehicle color noted as Black
05/12/2012	11,820	Doral Hyundai Doral, FL 305-591-5400 doralhyundai.com/  <b>1,038</b> Customer Favorites	 <b>Vehicle serviced</b> -Maintenance inspection completed -3,750 mile service performed
08/06/2012	16,199	Doral Hyundai Doral, FL 305-591-5400 doralhyundai.com/  <b>1,038</b> Customer Favorites	 <b>Vehicle serviced</b> -Maintenance inspection completed -Fluids checked -Oil and filter changed -Steering wheel replaced -Tire condition and pressure checked -Tires rotated

02/21/2013	21,255	Doral Hyundai Doral, FL 305-591-5400 doralhyundai.com/ 1,038 Customer Favorites		<b>Vehicle serviced</b> -Pre-delivery inspection completed -Maintenance inspection completed -Air filter replaced -Cabin air filter replaced/cleaned -Fluids checked -Oil and filter changed -Tire condition and pressure checked -Tire(s) balanced -Tires rotated -Wiper(s) replaced
02/25/2013	21,400	Doral Hyundai Doral, FL 305-591-5400 doralhyundai.com		<b>Vehicle offered for sale</b>
03/09/2013		Hyundai CPO Dealer Miami, FL  <b>Hyundai Certified</b> Used Vehicles		<b>Sold as a Hyundai Certified Pre-Owned (CPO) Vehicle</b>
03/09/2013		Florida Motor Vehicle Dept.		<b>Vehicle purchase reported</b>
03/12/2013		Dealer Inventory Hialeah, FL		<b>Vehicle offered for sale</b>

**Owner 2**  
Purchased: 2013 Personal Vehicle

Date	Mileage	Source	Comments
03/27/2013		Florida Motor Vehicle Dept. Miami, FL Title #0107545842	<b>Title issued or updated</b> -Registration issued or renewed -New owner reported -Titled or registered as personal vehicle -Loan or lien reported -Vehicle color noted as Black
06/06/2013	23,702	Doral Hyundai Doral, FL 305-591-5400 doralhyundai.com/ 1,038 Customer Favorites	<b>Vehicle serviced</b> -Maintenance inspection completed -Headliner removed and reinstalled

**Owner 3**  
Purchased: 2013 Personal Vehicle  
14,838 mi/yr



**Low mileage!** This owner drove less than the industry average of 15,000 miles per year.

Date	Mileage	Source	Comments
08/19/2013		Florida Motor Vehicle Dept. Miami, FL Title #0107545842	<b>Vehicle purchase reported</b> -Title issued or updated -Registration issued or renewed -New owner reported -Titled or registered as personal vehicle -Vehicle color noted as Black
09/11/2013	25,849	Doral Hyundai Doral, FL 305-591-5400 doralhyundai.com/ 1,038 Customer Favorites	<b>Vehicle serviced</b> -Maintenance inspection completed -Oil and filter changed
10/15/2013	26,846	Doral Hyundai Doral, FL 305-591-5400 doralhyundai.com/	<b>Vehicle serviced</b> -Maintenance inspection completed -Exhaust secured

♥ 1,038 Customer Favorites

11/29/2013		Florida Motor Vehicle Dept. Miami, FL Title #0107545842		<b>Registration issued or renewed</b> - Titled or registered as personal vehicle - Vehicle color noted as Black
12/18/2013	28,754	Doral Hyundai Doral, FL 305-591-5400 doralhyundai.com/ ♥ 1,038 Customer Favorites		<b>Vehicle serviced</b> - Maintenance inspection completed - Fluids checked - Oil and filter changed - Tire condition and pressure checked - Tires rotated
08/01/2014	35,674	Doral Hyundai Doral, FL 305-591-5400 doralhyundai.com/ ♥ 1,038 Customer Favorites		<b>Vehicle serviced</b> - Maintenance inspection completed - Oil and filter changed
08/09/2014		Florida Motor Vehicle Dept. Miami, FL Title #0107545842		<b>Registration issued or renewed</b> - Titled or registered as personal vehicle - Vehicle color noted as Black
11/12/2014		Florida Motor Vehicle Dept. Miami, FL Title #0107545842		<b>Registration issued or renewed</b> - Titled or registered as personal vehicle - Vehicle color noted as Black
03/05/2015	44,221	Doral Hyundai Doral, FL 305-591-5400 doralhyundai.com/ ♥ 1,038 Customer Favorites		<b>Vehicle serviced</b> - 3,750 mile service performed - Air filter replaced - Brake light switch replaced - Cabin air filter replaced/cleaned - Drive belt(s) replaced - Light bulb(s) replaced - Oil and filter changed
05/18/2015	47,637	Kendall Hyundai Miami, FL 786-590-0396 kendallhyundai.com/ ♥ 11,185 Customer Favorites		<b>Vehicle serviced</b> - Electrical system checked
06/19/2015	49,527	Kendall Hyundai Miami, FL 786-590-0396 kendallhyundai.com/ ♥ 11,185 Customer Favorites		<b>Vehicle serviced</b> - Airbag clockspring/reel replaced
11/18/2015		Florida Motor Vehicle Dept. Miami, FL Title #0107545842		<b>Registration issued or renewed</b> - Titled or registered as personal vehicle - Registration updated when owner moved the vehicle to a new location - Vehicle color noted as Black
05/17/2016	65,648	Doral Hyundai Doral, FL 305-591-5400 doralhyundai.com/ ♥ 1,038 Customer Favorites		<b>Vehicle serviced</b> - Maintenance inspection completed

 **Owner 4**  
Purchased: 2016



**Low mileage!** This owner drove less than the industry average of 15,000 miles per year.

Personal Vehicle  
4,913 mi/yr

Date	Mileage	Source	Comments
06/24/2016	65,734	Florida	Vehicle purchase reported

Motor Vehicle Dept.  
Miami, FL  
Title #0107545842

- Title issued or updated
- Registration issued or renewed
- New owner reported
- Titled or registered as personal vehicle
- Loan or lien reported
- Vehicle color noted as Black

02/11/2017 71,822

Lehman Hyundai  
Miami, FL  
305-306-1637  
lehmanhyundai.com/  
♥ 525 Customer Favorites



- Vehicle serviced**
- Maintenance inspection completed
  - Brake rotor(s) resurfaced
  - Front brakes replaced
  - Oil and filter changed
  - Tires rotated
  - Vehicle washed/detailed

02/17/2017

Aventura Brake & Auto Service  
Miami, FL  
305-931-6603



**Vehicle serviced**

07/21/2017 76,480

Braman Miami Hyundai  
Miami, FL  
786-220-6929  
bramanmiamihyundai.com/  
♥ 17,876 Customer Favorites



- Vehicle serviced**
- Maintenance inspection completed
  - Vehicle washed/detailed

08/20/2018

Florida  
Motor Vehicle Dept.  
Miami, FL  
Title #0107545842

- Registration issued or renewed**
- Titled or registered as personal vehicle
  - Loan or lien reported
  - Vehicle color noted as Black

08/29/2019

Florida  
Motor Vehicle Dept.  
Miami, FL  
Title #0107545842

- Registration issued or renewed**
- Titled or registered as personal vehicle
  - Loan or lien reported
  - Registration updated when owner moved the vehicle to a new location
  - Vehicle color noted as Black

11/26/2019

Damage Report

- Accident reported: minor damage**
- Vehicle involved in a sideswipe collision with another motor vehicle
  - Damage to left side
  - Damage to left rear
  - Functional damage reported
  - Airbags did not deploy

**CARFAX HAS THE MOST ACCIDENT & DAMAGE INFORMATION**

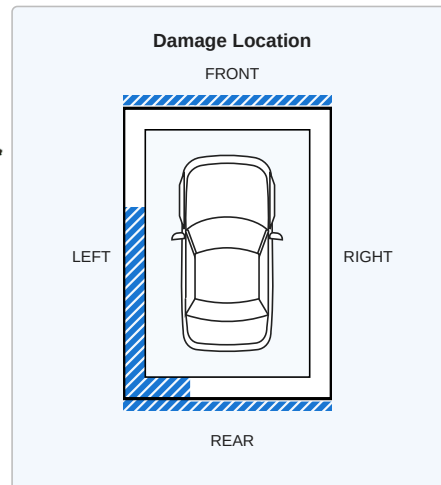
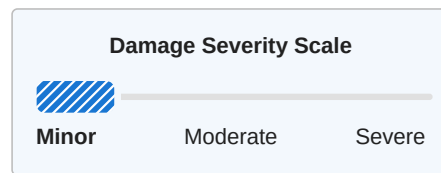

03/05/2020

Washington  
Motor Vehicle Dept.  
Seattle, WA

- Title issued or updated**
- Loan or lien reported

- Registration updated when owner moved the vehicle to a new location
- Vehicle color noted as Black

03/09/2020  
 Florida  
 Motor Vehicle Dept.  
 Miami, FL  
 Title #0107545842

**Registration issued or renewed**  
 -Titled or registered as personal vehicle  
 -Loan or lien reported  
 -Registration updated when owner moved the vehicle to a new location  
 -Vehicle color noted as Black

04/18/2020      94,238      COURTESY TIRE  
 Seattle, WA  
 206-932-5044  
 ❤️ 33 Customer Favorites



**Vehicle serviced**

05/05/2020  
 Washington  
 Motor Vehicle Dept.  
 Seattle, WA

**Title issued or updated**  
 -Correction to record  
 -Duplicate title issued  
 -Loan or lien reported  
 -Registration updated when owner moved the vehicle to a new location  
 -Vehicle color noted as Black

09/03/2020      Hyundai Motor America

**Manufacturer recall issued**  
 -NHTSA #20V393000  
 -Recall #193 2011-2012 ELANTRA (MD/UD), 2012 ACCENT (RB), 2012 VELOSTER (  
 -Status: Remedy Available

Click here or call 1-855-371-9460 to locate an authorized Hyundai dealer near you to obtain more information about this recall.

[+ Learn more about this recall](#)

03/26/2021      Damage Report



**Damage reported: minor to moderate damage**  
 -Damage to front

**CARFAX HAS THE MOST ACCIDENT & DAMAGE INFORMATION**

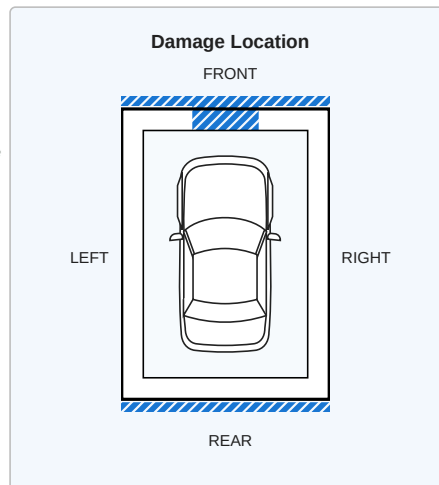
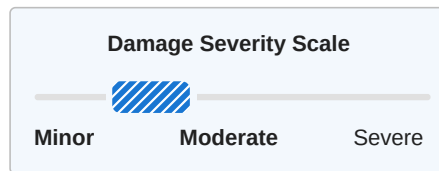

04/06/2021  
 Washington  
 Motor Vehicle Dept.  
 Seattle, WA

**Registration issued or renewed**  
 -Loan or lien reported  
 -Registration updated when owner moved the vehicle to a new location  
 -Vehicle color noted as Black

02/25/2022  
 Washington  
 Motor Vehicle Dept.  
 Seattle, WA

**Registration issued or renewed**  
 -Loan or lien reported  
 -Vehicle color noted as Black

04/16/2023		Washington Motor Vehicle Dept. Edmonds, WA		<b>Registration issued or renewed</b> - Loan or lien reported - Registration updated when owner moved the vehicle to a new location - Vehicle color noted as Black
08/25/2023	101,707	Jeff's Auto Repair Lynnwood, WA 206-350-2161 jeffsauto.com/ 8 Customer Favorites		<b>Vehicle serviced</b> - Maintenance inspection completed - Battery/charging system checked - Battery replaced - Brake fluid flushed/changed - No-start/hard start condition checked - Wiring repaired
09/01/2023		Florida Motor Vehicle Dept. Seattle, WA Title #0107545842		<b>Title issued or updated</b> - Registration issued or renewed - Duplicate title issued - Titled or registered as personal vehicle - Loan or lien reported - Registration updated when owner moved the vehicle to a new location - Vehicle color noted as Black
10/19/2023	101,715	Elliott Bay Auto Brokers Seattle, WA 206-282-5900 ebautobrokers.com/ 1,507 Customer Favorites		<b>Vehicle sold</b>

**Owner 5** Personal Vehicle  
Purchased: 2024

Date	Mileage	Source		Comments
02/29/2024		Washington Motor Vehicle Dept. Lynnwood, WA Title #1881579379		<b>Title issued or updated</b> - New owner reported - Vehicle color noted as Black
05/24/2024	107,209	STS Quality Auto Care Lynnwood, WA 425-787-6600 stsqualityautocare.com/ 438 Customer Favorites		<b>Vehicle serviced</b> - A/C refrigerant recharged - Battery/charging system checked - Brakes checked - Oil and filter changed - Tire pressure monitoring system checked
07/19/2024	111,589	STS Quality Auto Care Lynnwood, WA 425-787-6600 stsqualityautocare.com/ 438 Customer Favorites		<b>Vehicle serviced</b> - Brakes checked - Engine mount(s) replaced
02/03/2025		Washington Motor Vehicle Dept. Lynnwood, WA Title #1881579379		<b>Registration issued or renewed</b> - Vehicle color noted as Black
02/27/2025	127,231	Doug's Lynnwood Mazda Edmonds, WA 425-774-3551 https://dougmazda.com/ 13,863 Customer Favorites		<b>Vehicle serviced</b>
01/17/2026		Damage Report		<b>Accident reported</b> - Vehicle involved in a rear-end collision with another motor vehicle - Airbags did not deploy

Have Questions? Consumers, please visit our Help Center at [www.carfax.com](http://www.carfax.com). Dealers or Subscribers, please visit our Help Center at [www.carfaxonline.com](http://www.carfaxonline.com).



**Accident Indicator**

CARFAX receives information about accidents in all 50 states, the District of Columbia and Canada.

Not every accident is reported to CARFAX. As details about the accident become available, those additional details are added to the CARFAX Vehicle History Report. CARFAX recommends that you have this vehicle inspected by a qualified mechanic.

- According to the National Safety Council, Injury Facts, 2021 edition, 5% of the 276 million registered vehicles in the U.S. were involved in an accident in 2019. Over 77% of these were considered minor or moderate.
- This CARFAX Vehicle History Report is based only on information supplied to CARFAX and available as of 4/3/26 at 3:22:58 AM (CDT). Other information about this vehicle, including problems, may not have been reported to CARFAX. Use this report as one important tool, along with a vehicle inspection and test drive, to make a better decision about your next used car.

**Damage Indicator**

Damage can be a result of many different types of events. Examples include contact with objects (other cars, trees, traffic signs, road debris, etc), vandalism, or weather-related events. Not every damage event is reported to CARFAX. As details about the damage event become available, those additional details are added to the CARFAX Vehicle History Report. CARFAX recommends that you have this vehicle inspected by a qualified mechanic.

- This CARFAX Vehicle History Report is based only on information supplied to CARFAX and available as of 4/3/26 at 3:22:58 AM (CDT). Other information about this vehicle, including problems, may not have been reported to CARFAX. Use this report as one important tool, along with a vehicle inspection and test drive, to make a better decision about your next used car.

**Damage Severity**

Damage events result in one of the following severity levels:

- Minor: Generally, minor damage is cosmetic (including dents or scratches), may only require reconditioning, and typically does not compromise a vehicle's operation and/or safety.
- Moderate: Moderate damage may affect multiple components of the vehicle and may impair the vehicle's operation and/or safety.
- Severe: Severe damage usually affects multiple components of the vehicle and is likely to compromise the vehicle's operation and/or safety.

CARFAX recommends getting a pre-purchase inspection at a certified collision repair facility.

**First Owner**

When the first owner(s) obtains a title from a Department of Motor Vehicles as proof of ownership.

**Manufacturer Recall**

Automobile manufacturers issue recall notices to inform vehicle owners of a safety defect or failure to meet minimum federal safety or emissions standards. Manufacturer recalls are repaired at no cost to the customer.

**New Owner Reported**

When a vehicle is sold to a new owner, the Title must be transferred to the new owner(s) at a Department of Motor Vehicles.

**Ownership History**

CARFAX defines an owner as an individual or business that possesses and uses a vehicle. Not all title transactions represent changes in ownership. To provide estimated number of owners, CARFAX proprietary technology analyzes all the events in a vehicle history. Estimated ownership is available for vehicles manufactured after 1991 and titled solely in the US including Puerto Rico. Dealers sometimes opt to take ownership of a vehicle and are required to in the following states: Maine, Massachusetts, New Jersey, Ohio, Oklahoma, Pennsylvania and South Dakota. Please consider this as you review a vehicle's estimated ownership history.

**Title Issued**

A state issues a title to provide a vehicle owner with proof of ownership. Each title has a unique number. Each title or registration record on a CARFAX report does not necessarily indicate a change in ownership. In Canada, a registration and bill of sale are used as proof of ownership.

[Full Glossary](#)

Follow Us: [facebook.com/CARFAX](https://facebook.com/CARFAX) [@CARFAXinc](https://twitter.com/CARFAXinc) [About CARFAX](#)

CARFAX DEPENDS ON ITS SOURCES FOR THE ACCURACY AND RELIABILITY OF ITS INFORMATION. THEREFORE, NO RESPONSIBILITY IS ASSUMED BY CARFAX OR ITS AGENTS FOR ERRORS OR OMISSIONS IN THIS REPORT. CARFAX FURTHER EXPRESSLY DISCLAIMS ALL WARRANTIES, EXPRESS OR IMPLIED, INCLUDING ANY IMPLIED WARRANTIES OF MERCHANTABILITY OR FITNESS FOR A PARTICULAR PURPOSE.

© 2026 CARFAX, Inc., part of S&P Global. All rights reserved.  
4/3/26 3:22:58 AM (CDT)

I have reviewed and received a copy of the CARFAX Vehicle History Report for this 2012 HYUNDAI ELANTRA vehicle (VIN: KMHDH4AE3CU268786), which is based on information supplied to CARFAX and available as of 4/3/26 at 4:22 AM (EDT).

Customer Signature

Date

Dealer Signature

Date